

062.8500 Fully divisible wheeled stand (light series)

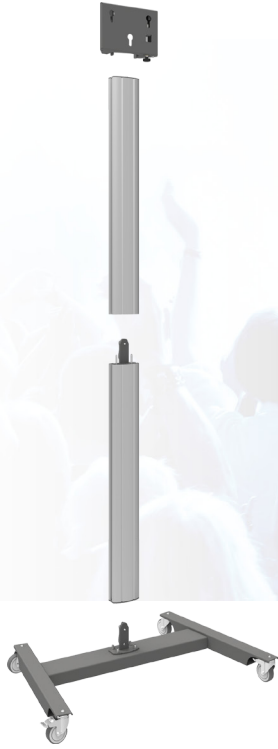

MOUNTING INSTRUCTIONS

MOUNTING INSTRUCTIONS

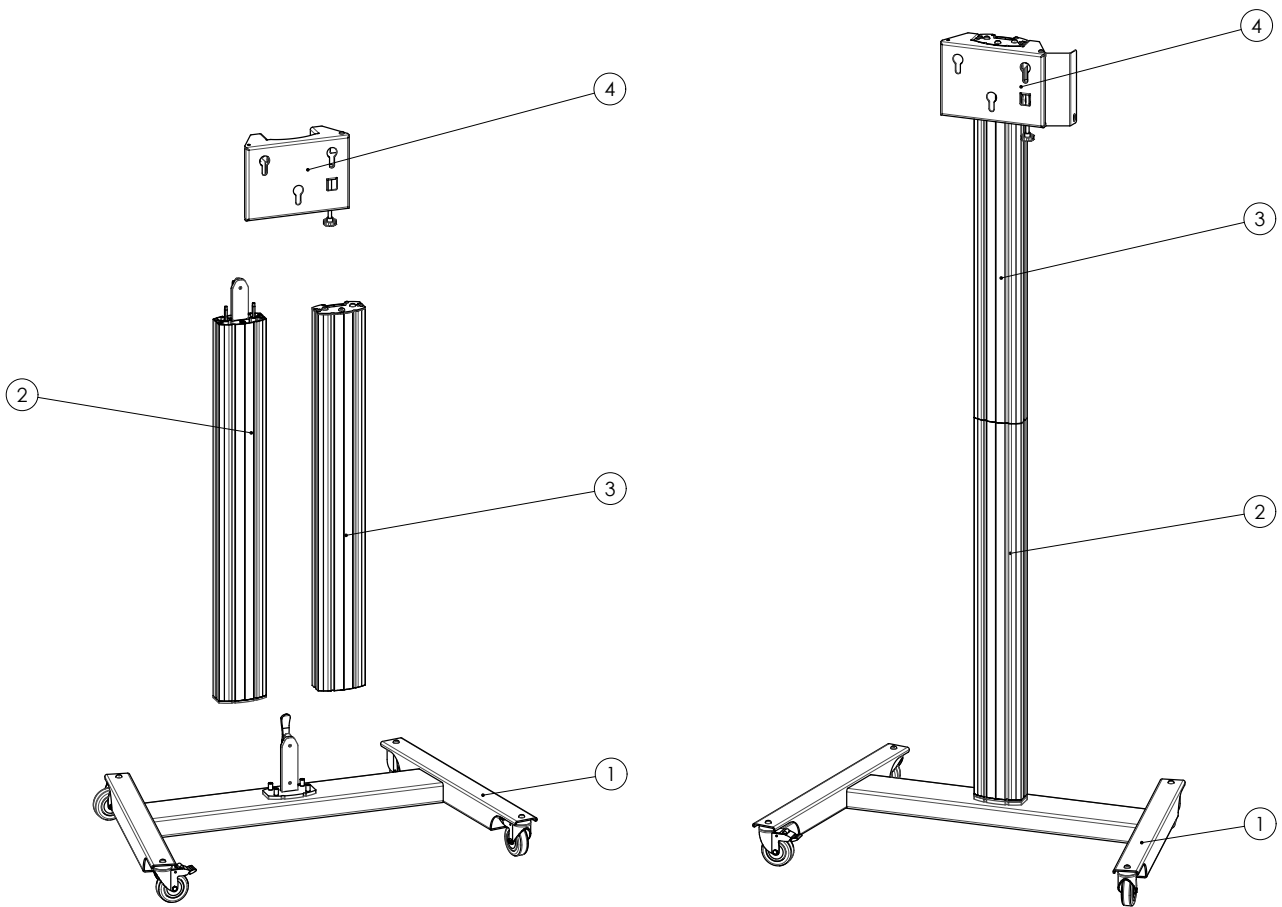

MAX 30kg

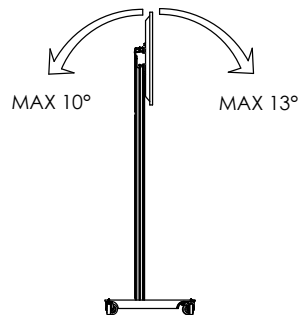

MOUNTING INSTRUCTIONS

MOUNTING INSTRUCTIONS

01

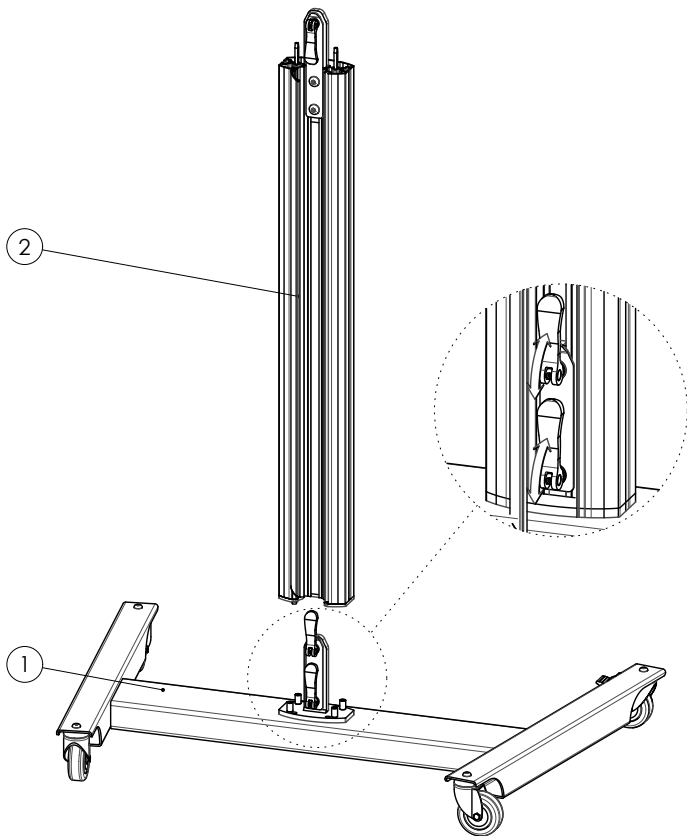

02

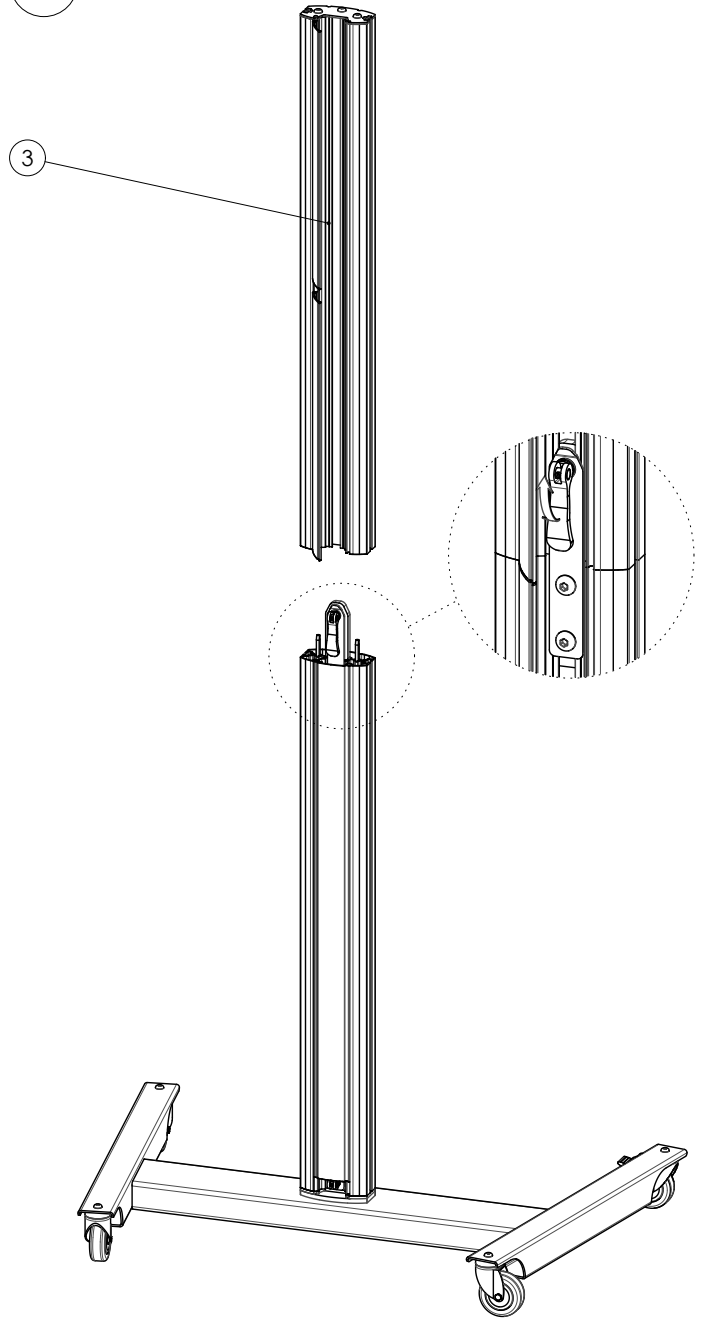

MOUNTING INSTRUCTIONS

MOUNTING INSTRUCTIONS

03

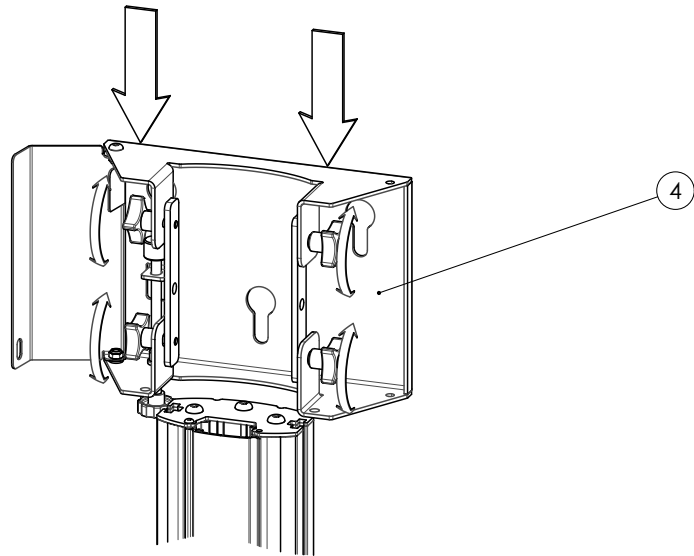

04

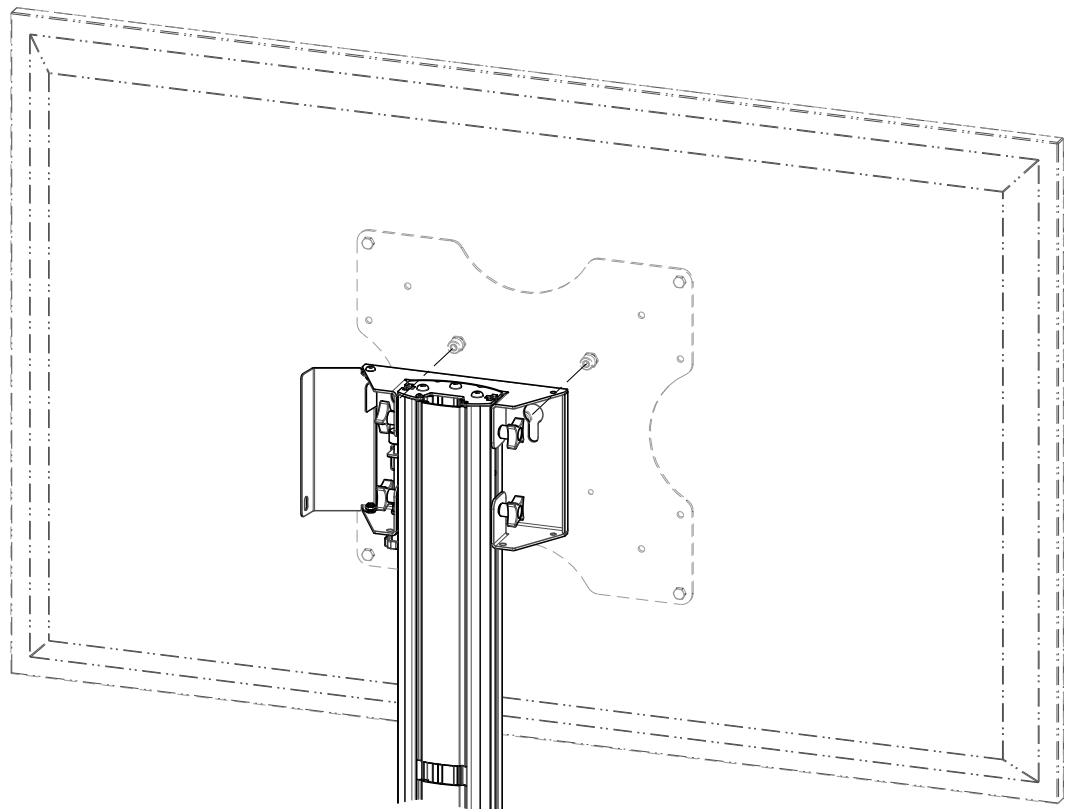

MOUNTING INSTRUCTIONS

MOUNTING INSTRUCTIONS

05

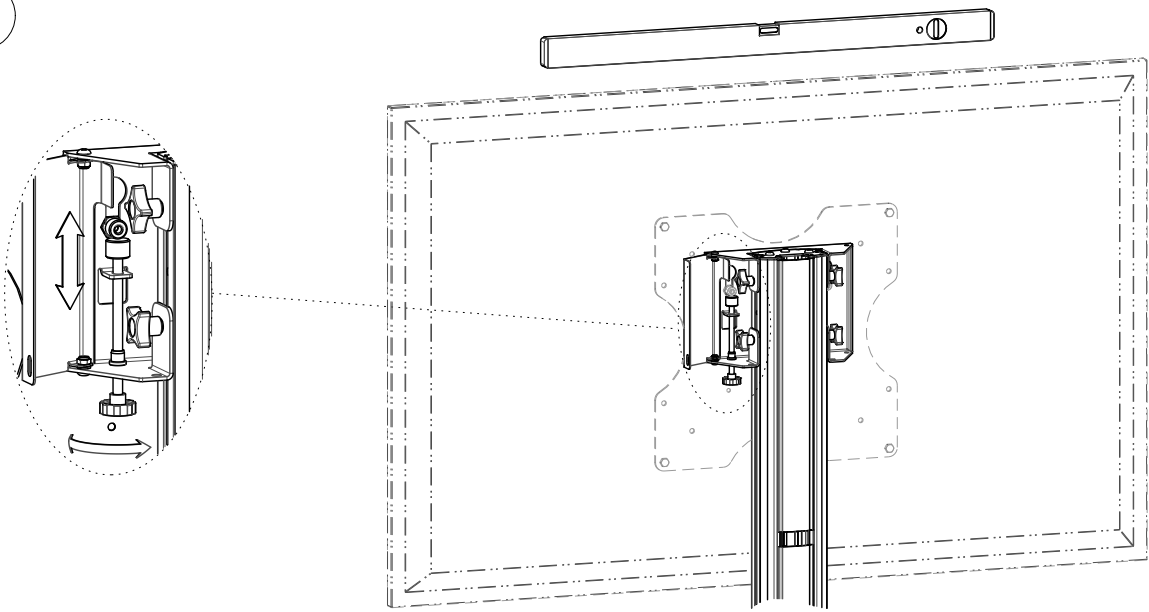

06

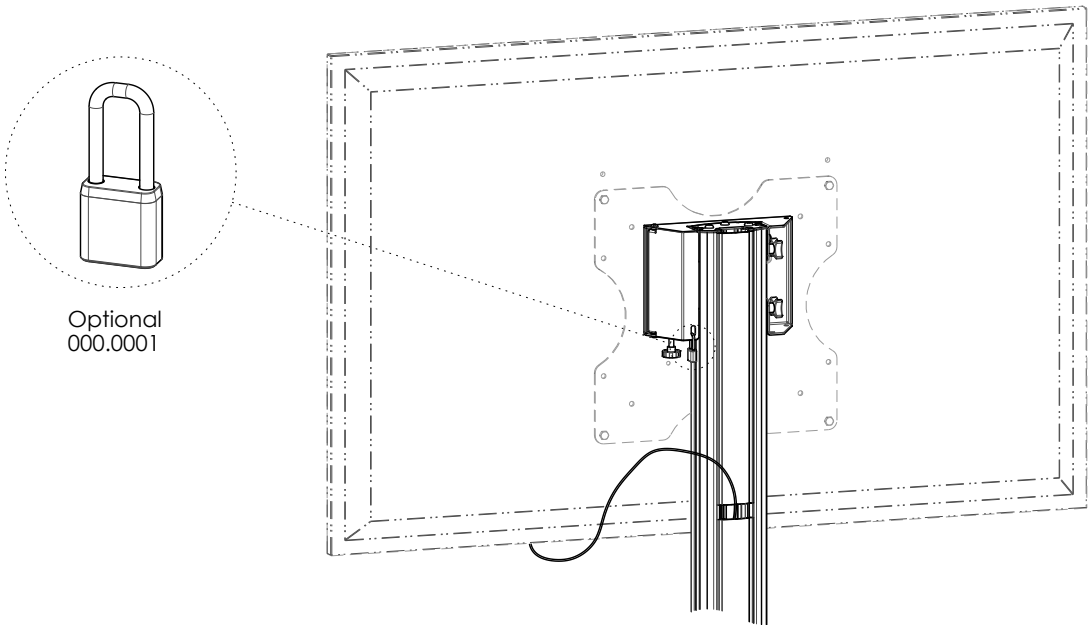

CONTACT

SMARTSELECTOR

Find your solution fast and easy with the mobile SmartSelector. Scan the QR code and find your solutions within 3 steps with the mobile SmartSelector

TRY NOW!

SmartMetals Mounting Solutions B.V.
Handelsweg 4
4231 EZ Meerkerk
The Netherlands
P +31 (0)183352942
F +31 (0)183352909

E info@SmartMetals.eu
W www.SmartMetals.eu

